

CARTILAGE AND TENDON INSTRUMENTS



SECTION P



To retrieve, grasp, hold, cut and separate cartilage and tendons.

CONTENTS

Cartilage Instruments	1-2
Tendon Instruments	2-3
Tendon Grasping Forceps	4
Tendon Strippers	5
Cartilage Knives	5
Tissue Graspers	6

ORTHO+MED
The Surgical Instrument Specialists



OM 46-0828
8" (203mm)
two serrated blades

MARTIN CARTILAGE SCISSORS

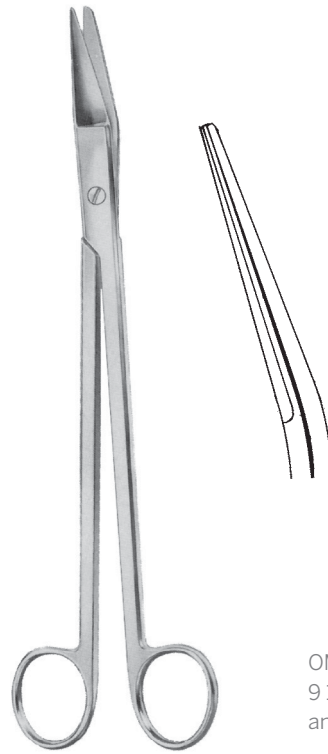

OM 46-0821
9 1/2" (241mm)
angular

MUELLER CAPSULE SCISSORS

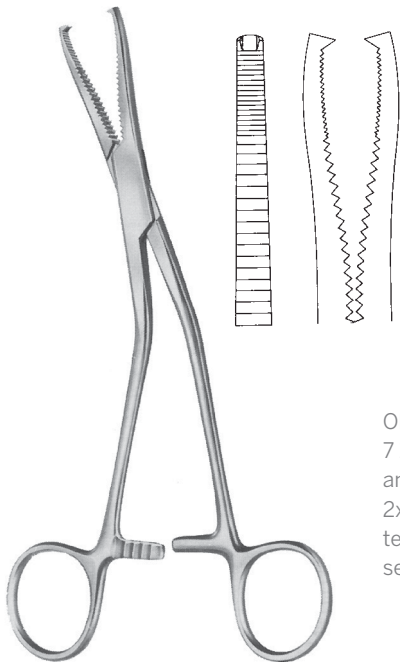

OM 46-0804
7 1/2" (191mm)
angular
2x2 sharp
teeth
serrated jaws

DINGMAN FORCEPS

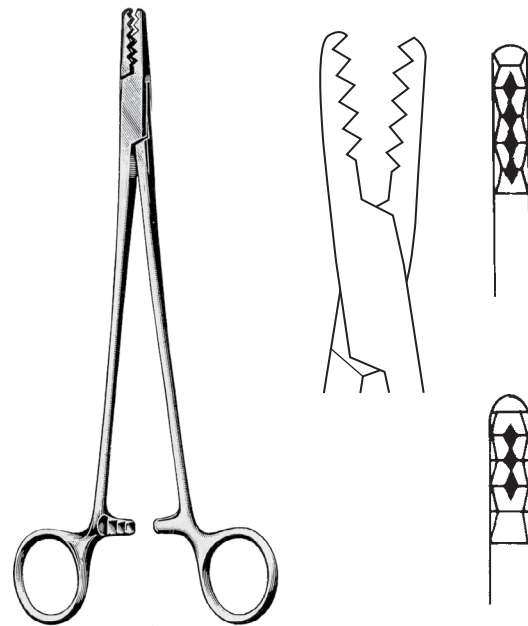

OM 46-0802 7 1/4" (174mm) deep teeth
OM 46-0814 8" (203mm) deep teeth

MARTIN CARTILAGE CLAMP



OM 46-0818
8" (203mm)
slightly curved

WALTON CARTILAGE CLAMP

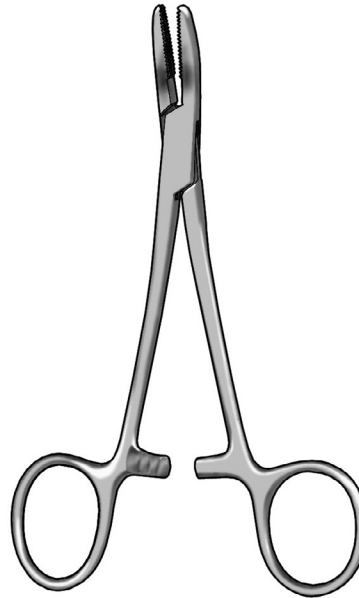

OM 46-0744
5 3/8" (137mm)
serrated, straight

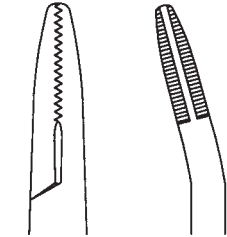

OM 46-0746
5 3/8" (137mm)
serrated, angled 20°

MENISCUS CLAMP

*For grasping tags of
the meniscus.*

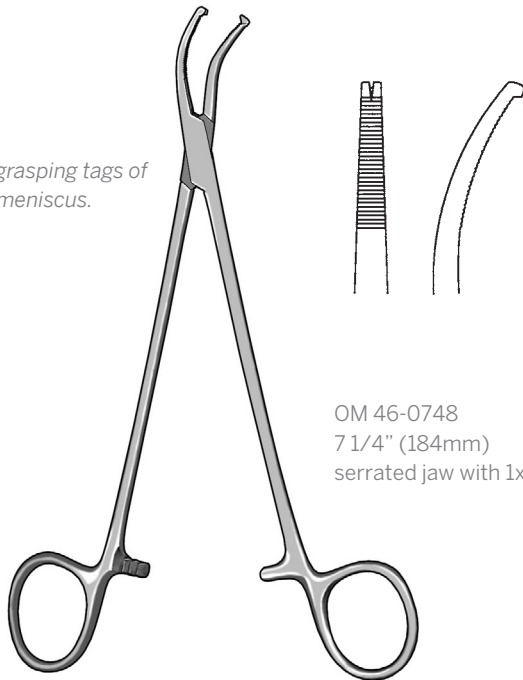

OM 46-0748
7 1/4" (184mm)
serrated jaw with 1x2 tip

**PRESTON LIGAMENTUM FLAVUM
FORCEPS (MENISCUS)**

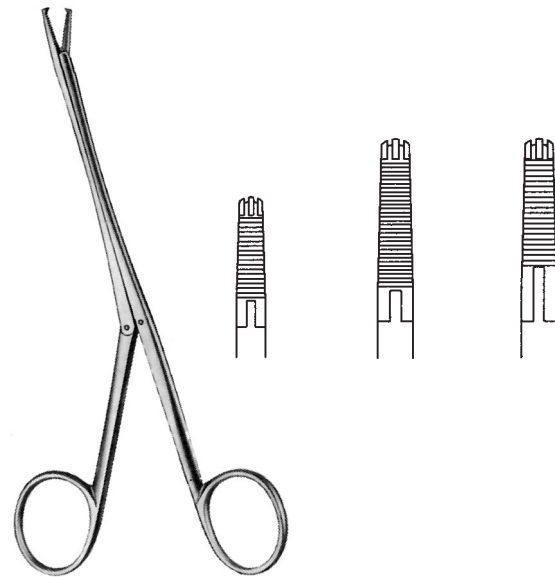

OM 46-0736 6" (152mm) angular shaft
OM 46-0737 7 1/2" (191mm) angular shaft
OM 46-0738 9 1/2" (241mm) angular shaft

BRAND TENDON PULLING FORCEPS



OM 90-1883 sharp
OM 90-1884 blunt

MENISCAL CLAMP 7"



OM 46-0739 8" (203mm)
serrated
with sharp teeth
OM 46-0735 8" (203mm)
serrated
with sharp teeth
flexible shaft

**KLEINERT-KUTZ
TENDON RETRIEVER**

INLET CLOSURE NON-DISPOSABLE

OM 1700040
9 1/2" (241mm)
with cleaning port

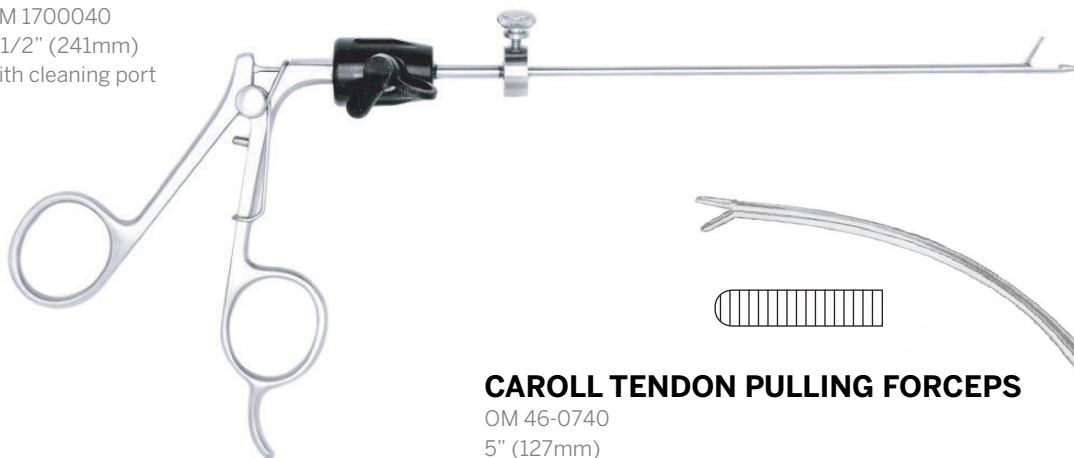

CAROLL TENDON PULLING FORCEPS

OM 46-0740
5" (127mm)
curved shaft
serrated

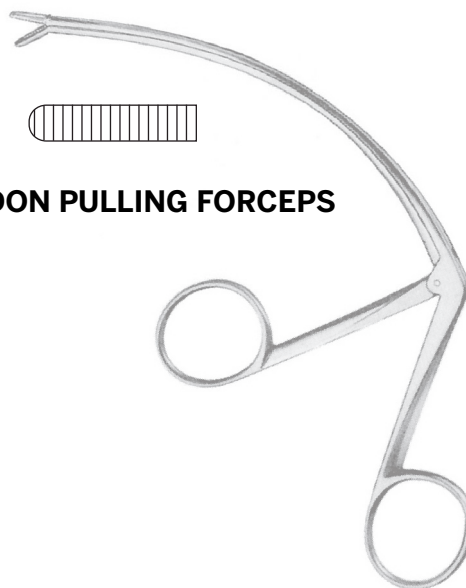

SUTURE GUIDE

OM 6060 10mm
OM 6070 12mm

TENDON GRASPING FORCEPS

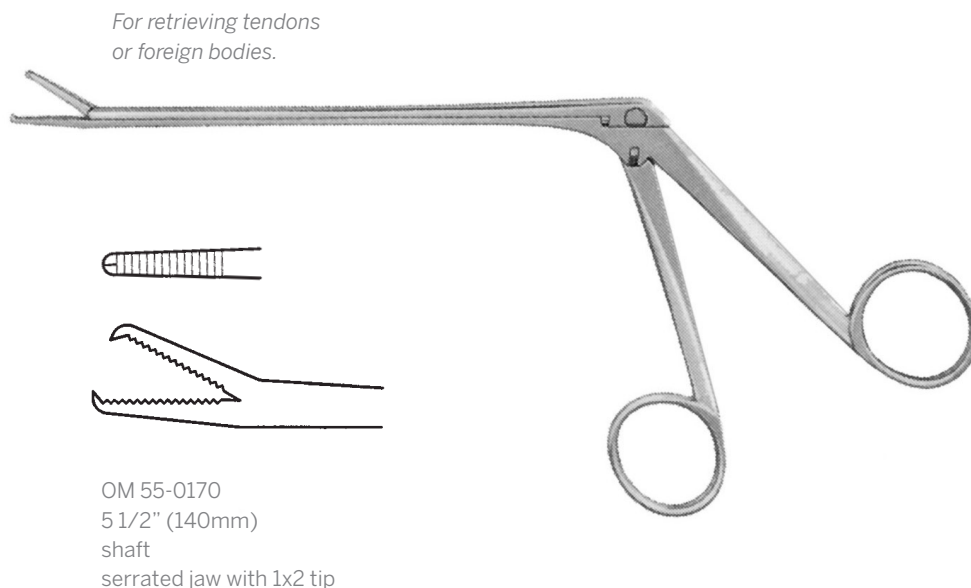

HOEN GRASPING FORCEPS

Designed with one long jaw. Longer jaw extends 5mm and pierces the host tendon. The jaw then grasps the graft. When pulled back it draws the graft through the host to complete the first weave.



OM 46-0742 straight
OM 46-0743 curved

TENDON WEAVING FORCEPS

6 1/4" (159mm)



- OM 46-0730
3mm
- OM 46-0731
4mm
- OM 46-0732
5mm
- OM 46-0733
6mm
- OM 46-0734
7mm

BUNNELL TENDON STRIPPER
6" (152mm)

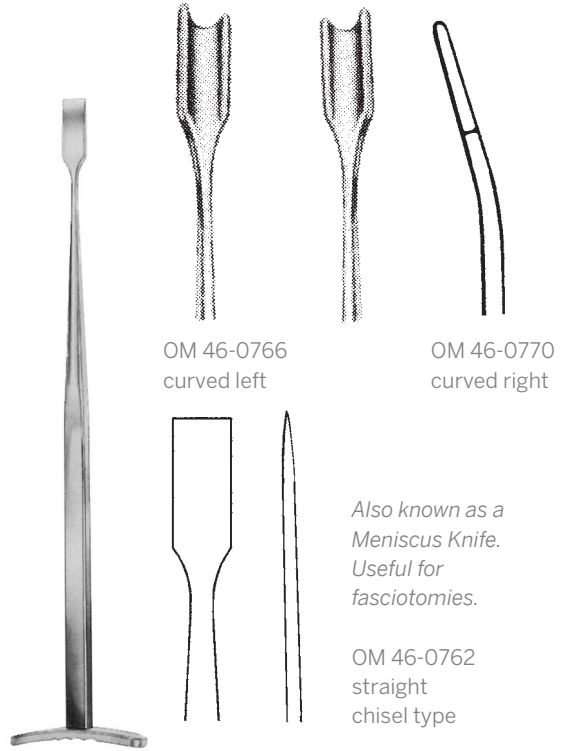

OM 46-0766
curved left

OM 46-0770
curved right

*Also known as a
Meniscus Knife.
Useful for
fasciotomies.*

OM 46-0762
straight
chisel type

SMILLIE KNIFE
6 3/4" (172mm)



OM 46-0741
10" (254mm)
straight edge with guards
curved blade

**LOWE-BRECK
CARTILAGE KNIFE**

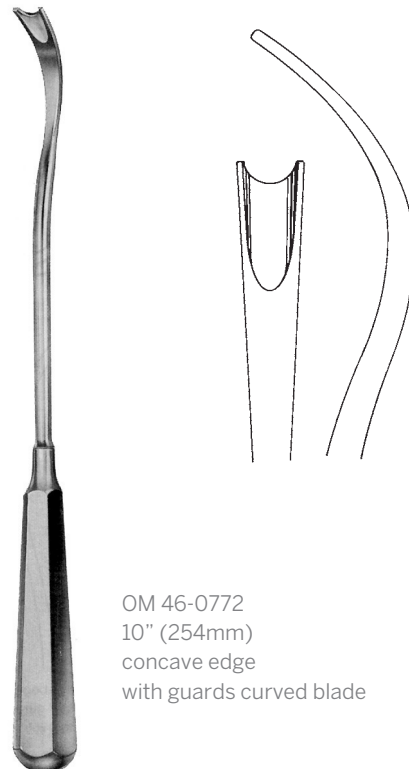

OM 46-0772
10" (254mm)
concave edge
with guards curved blade

DOWNING CARTILAGE KNIFE



CEMENT GRASPER

OM RW8800 9 3/4" overall length (7" shaft, 15mm x 3.5mm cup)

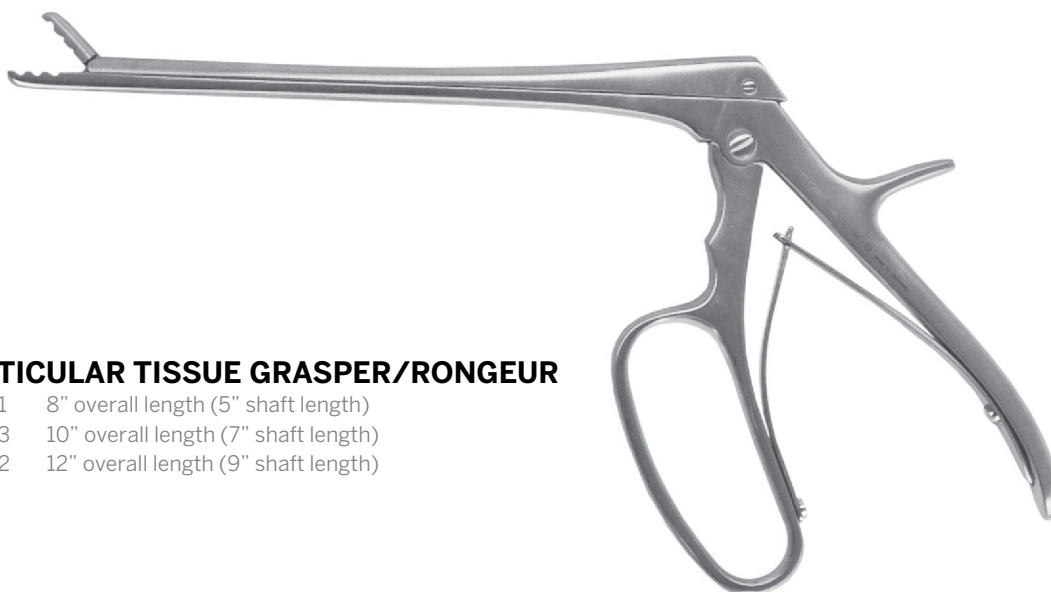

INTRA-ARTICULAR TISSUE GRASPER/RONGEUR

- OM 90-1790-01 8" overall length (5" shaft length)
- OM 90-1790-03 10" overall length (7" shaft length)
- OM 90-1790-02 12" overall length (9" shaft length)

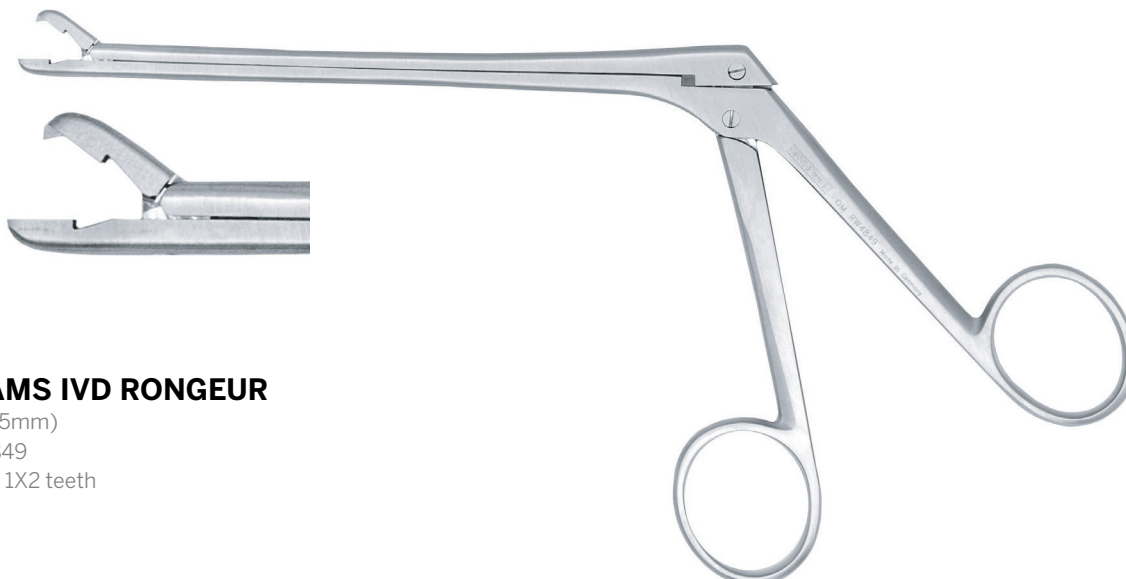

WILLIAMS IVD RONGEUR

5 1/4" (135mm)
OM RW4849
2mm with 1X2 teeth